

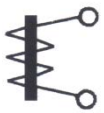
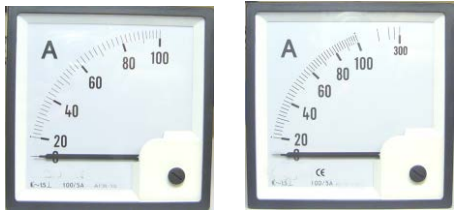
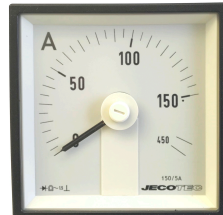

Type	APM-T	1x In 90° / 3x In 90°	250°	KLY - L
	APM 48 T 48 x 48			KLY - L 48 48 x 48
	APM 72 T 72 x 72			KLY - L 72 72 x 72
	APM 96 T 96 x 96			KLY - L 96 96 x 96
				

Instrumente für Wechselstrom und Wechselspannung mit auswechselbarer Skala	Instruments pour courant et tension alternative avec cadran interchangeable.	Instruments for AC measuring with interchangeable scale	Amperometri e Voltmetri per corrente alternata con scala intercambiabile.
Klasse 1,5 (1.0)**	Classe 1,5 (1.0)**	Accuracy class 1,5 (1.0)**	Precisione 1,5 (1.0)**
Dämpfung: Silikonöllager	Amortissement: A huile de silicone	Damping: Silicon Oil	Smorzamento: Silicone olio
Lagerung: Kunstsaphir	Pivotage: Saphir	Bearing: Sapphire	Supporti: Zaffiro
Zulassungen / Approuvée / Approvals / Conforme a : CE / KEMA EUR			

Type					48	72	96
Frontrahmen	Collerette	Front frame	Dimensionifrontali	mm	48 x 48	72 x 72	96 x 96
Ausschnitt	Découpe	Panel cut out	Foratura pannello	mm	44,5 x 44,5	67 x 67	91 x 91
Einbautiefe	Profondeur	Mount. Depth	Profondità d'incasso	mm	60	65 / 105	65 / 105
Prüfspannung	Tension d'essai	Testingvoltage	Tensione di prova		2 kV	2 kV	2 kV
Temperaturbereich	Températ. de fonction.	Operating temperature	Temp. di funzionam.		-20 ..+ 40°C	-20 ..+ 40°C	-20 ..+ 40°C
Eigenverbrauch	Consomation	Self consumption	Autoconsumo	V	3 VA	3 VA	3 VA
Eigenverbrauch	Consomation	Self consumption	Autoconsumo	A	1,5 VA	1,5 VA	1,5 VA
Skalenlänge	Long. d'échelle	Scale length(arc length)	Lunghezza di scala	90° 250°	41mm 67mm	63mm 110mm	94mm 151mm
Vibrationsfestigkeit	Résist. auxvibrat.	Vibration resistant	Res. alle vibrazioni		... 2.5 g		
Schockfestigkeit	Résist. aux chocs	Shockresistent	Res. all' urto		... 15 g		
Installationskategorie – Catégorie d'installation – Installation category – Categoria III					300V	300V	600V

Strommesser - direkt Ampèremètre - direct Ammeter – direct range Amperometri – port. diret.		StrommesserWandleranschl. Amp.- mètre sur T C Ammeterwithcurrenttransf. Amperometri su TA		StrommesserWandleranschl. Amp.- mètre sur T C Ammeterwith curent transf. Amperometri su TA		Spannungsmesser Votlmètre Voltmeter Voltmetri	
APM-T 90° KLY- L 250°	APM-T 90°	APM-T 90° KLY – L 250°	APM-T 90°	APM-T 90° KLY – L 250°	APM-T 90°	APM-T 90°	KLY – L 250°
1 x In	3 x In (90°)	1 x In	3 x In (90°)	1 x In**	3 x In (90°)**		
0.5A	0.5 / 1.5A	10 / 5 A	10 / 30 / 5 A			40 V	48 / 72/ 96
1,0 A	1,0 / 3,0 A	15 / 5 A	15 / 45 / 5 A			60 V	48 / 72/ 96
1,5 A	1,5 / 4,5 A	20 / 5 A	20 / 60 / 5 A			100 V	48 / 72/ 96
2,5 A	2,5 / 7,5 A	25 / 5 A	25 / 75 / 5 A	25 / 1 A	25/ 75/ 1 A	150 V	48 / 72/ 96
4,0 A	4,0 / 12 A	30 / 5 A	30 / 90 / 5 A	30 / 1 A	30/90/ 1 A	250 V	48 / 72/ 96
6,0 A	6,0 / 18 A	40 / 5 A	40 / 120 / 5 A	40 / 1 A	40/120/ 1 A	300 V	48 / 72/ 96
10 A	10 / 30 A	50 / 5 A	50 / 150 / 5 A	50 / 1 A	50 /150/ 1 A	400 V	48 / 72/ 96
15 A	15 / 45 A	60 / 5 A	60 / 180 / 5 A	60 / 1 A	60/180/ 1 A	500 V	48 / 72/ 96
20 A	20 / 60 A	75 / 5 A	75 / 225 / 5 A	75 / 1 A	75/225/ 1 A	600 V	72 / 96
25 A	25 / 75 A	80 / 5 A	80 / 240 / 5 A	80 / 1 A	80/240/ 1 A		
40 A	40 / 120 A	100 / 5 A	100 / 300 / 5 A	100 / 1 A	100/300/ 1 A		
60 A	60 / 180 A	150 / 5 A	150 / 450 / 5 A	150 / 1 A	150/450/ 1 A		
		200 / 5 A	200 / 600 / 5 A	200 / 1 A	200/ 600/ 1 A		
		250 / 5 A	250 / 750 / 5 A	250 / 1 A	250/ 750/ 1 A		
		300 / 5 A	300 / 900 / 5 A	300 / 1 A	300/900/ 1 A		
		400 / 5 A	400 / 1 200 / 5 A	400 / 1 A	400/1200/ 1 A		
		500 / 5 A	500 / 1 500 / 5 A	500 / 1 A	500/1500/ 1 A		
		600 / 5 A	600 / 1 800 / 5 A	600 / 1 A	600/1800/ 1 A		
		750 / 5 A	750 / 2 250 / 5 A	750 / 1 A	750/2250/ 1 A		
		800 / 5 A	800 / 2 400 / 5 A	800 / 1 A	800/2400/ 1 A		
		1 000 / 5 A	1 000/ 3 000 / 5 A	1 000 / 1 A	1000/3000/ 1 A		
		1 200 / 5 A	1 200 / 3 600 / 5 A	1 200 / 1 A	1200/3600/ 1 A		
		1 500 / 5 A	1 500 / 4 500 / 5 A	1 500 / 1 A	1500/4500/ 1 A		
		2 000 / 5 A	2 000 / 6 000 / 5 A				
		2 500 / 5 A	2 500 / 7 500 / 5 A				
		3 000 / 5 A	3 000 / 9 000 / 5 A				
		4 000 / 5 A	4 000 / 12 000 / 5 A				

** AUF ANFRAGE – SUR DEMANDE – OPZIONI - OPTIONS

Klasse (1.0)**	Classe (1.0)**	Accuracy class (1.0)**	Precisione (1.0)**
----------------	----------------	------------------------	--------------------



Pushing Tight Type (IV)

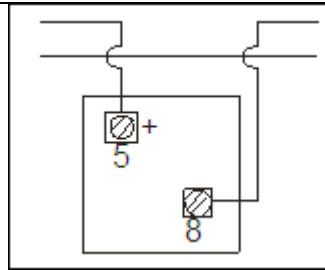

AC Ammeter

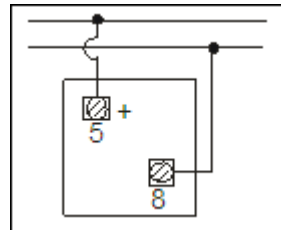

AC Voltmeter

Connection Diagram



Voltmeter

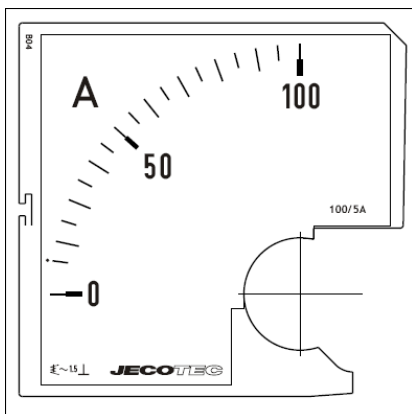

Scale AC Ammeter 1xIn
0..100A/5Aac-90°

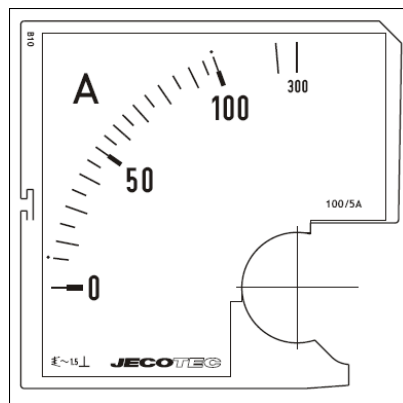

Scale AC Ammeter 3xIn
0..100/300A/5Aac 90°

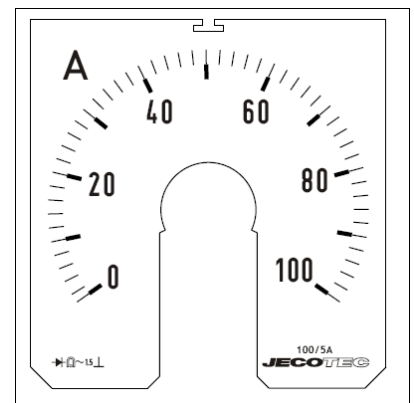

Scale AC Ammeter 1xIn
0..100A/5Aac 250°

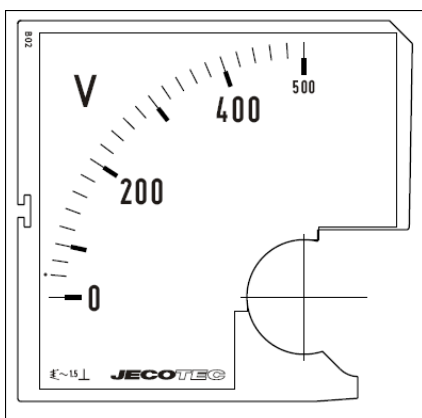

Scale AC Voltmeter
0..500Vac 90°

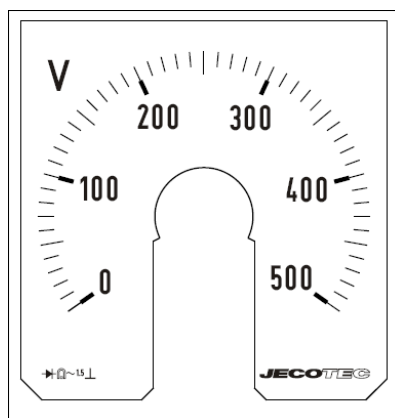











Scale AC Voltmeter 0..500Vac
250°

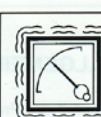

auf Anfrage
mit rotem Markierungszeiger
option with red marking pointer

AUF ANFRAGE – SUR DEMANDE – OPZIONI – OPTIONS

	<p>TROPENAUFSÜHRUNG VERSION TROPICALE TROPICALIZZAZIONE TROPICALISATION</p>		<p>SCHUTZART IP54 – IP65 PROTECTION IP54 – IP65 GRADI DI PROTEZIONE IP54 – IP65 PROTECTION DEGREE IP54 – IP65</p>
	<p>SCHIFFSAUFSÜHRUNG POUR EMPLOI MARINE PER IMPIEGO MARINO SHIP-MOUNTING VERSION</p>		<p>BAHNAUFSÜHRUNG POUR EMPLOI CH. DE FER PER IMPIEGO FERROVIARI FOR RAILWAY</p>
	<p>ERHÖHTE RÜTTELFESTIGKEIT CONSTRUCT. ANTIVIBRATION ESECUZIONE ANTIVIBRANTE VIBRATION PROOF VERSION</p>		<p>MIT HINTERGRUNDBELEUCHTUNG AVEC CADRAN ÉCLAIRÉ CON QUADRANTE ILLUMINATO WITH SCALE ILLUMINATION</p>
	<p>FÜR FOTOVOLTAIK POUR SYST. PHOTOVOLTAIQUES PER IMPIANTI FOTOVOLTAICI FOR SOLAR PLANT</p>		<p>AUFSÜHRUNG FÜR H₂S PROTECTION POUR H₂S ESECUZIONE PER H₂S H₂S PROOF VERSION</p>
	<p>DOPPELISOLIERUNG DOUBLE ISOLEMENT DOPPIO ISOLAMENTO DOUBLE ISOLATION</p>		<p>GOST-R RUSSIAN METROLOGICAL CERTIFICATIONS UKRMETR TEST STANDARD FOR UCRAINIAN MARKET</p>